



reddot award 2014  
winner lighting design



# orbio360<sup>®</sup>

FLEXIBLE INNOVATION



orbio360<sup>®</sup>

IP65 AC 240V LED Fire Rated Downlight

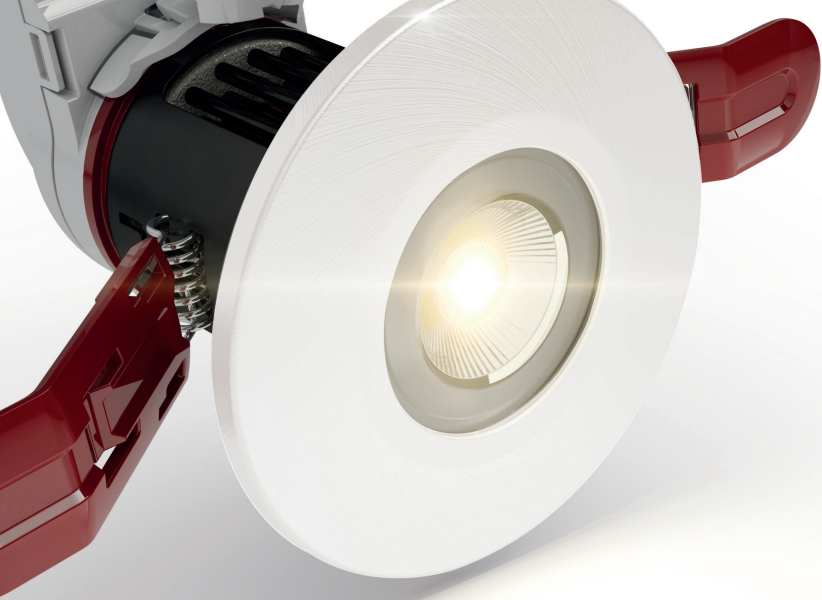

## Designed to **Deliver...**

This award-winning LED fire rated downlight incorporates the very latest in AC LED technology. Its many ingenious design features combine to keep installation costs to an absolute minimum.

Fast-fit plug and socket with loop-in, loop-out connections enable fast and easy installation.

As well as offering full fire rated protection, Orbio360's clever rotational 280 degree ratchet enables it to be used in restricted lighting applications where roof or ceiling joists are an obstruction.

Winner of the Red Dot award for design excellence, Orbio360® has an adjustable height dimension for shallow ceiling voids, as low as 65mm.

**Discover more about the  
Orbio360® inside ...**



**reddot** award 2014  
winner



### *Twistlock*

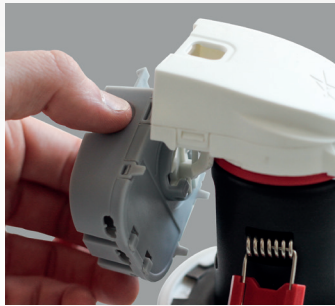

Unique twist lock design protects the product socket during transportation.

### *Quick Connect*



Fast wiring connection is achieved via the integral plug and socket feature. The socket terminals accept solid or stranded cable, with screw terminals for reliability and security. The socket connection also provides a loop-in, loop-out facility for 3x1.5mm Twin and Earth Cables.

### *Press and Release*

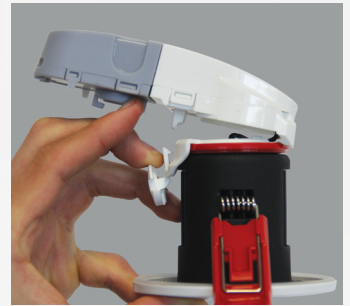

Precision engineered 'press and release' mechanism cleverly reduces the height of the product to 65mm for shallow ceiling voids.

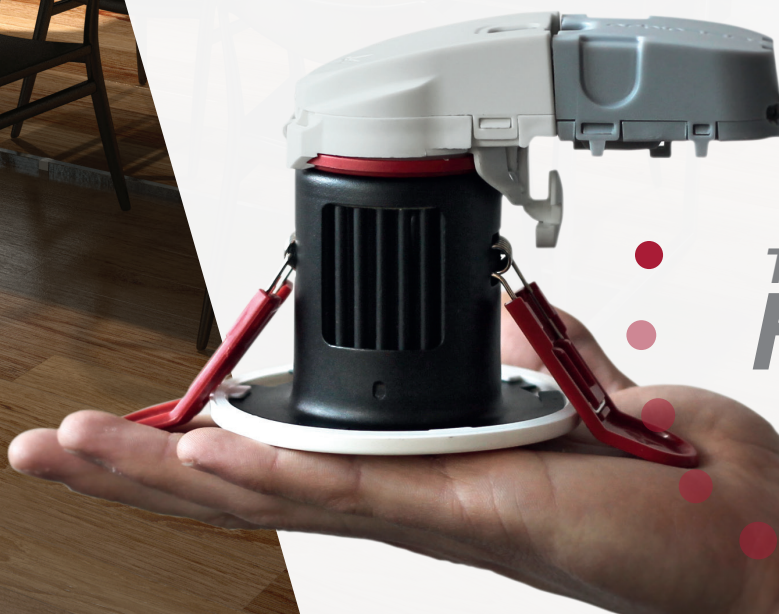

*Time in your  
Hands*

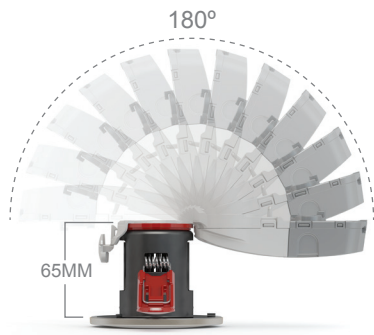

◀ For shallow ceiling voids Orbio360® can simply 'press, release and flip', providing 180 degrees movement. This will provide a reduced product height of 65mm.

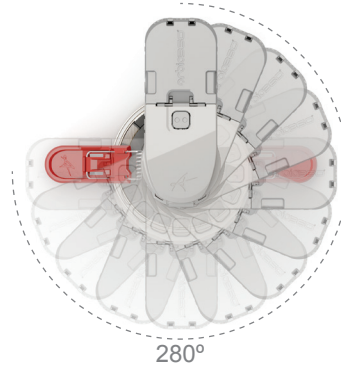

◀ For restricted installations, where roof/ceiling joists can be an obstruction, Orbio360® can be rotated by 280 degrees.

▶ Double Insulated cables give total protection when installed in the flipped position.



▶ Exceptional thermal performance allows continuous mineral insulation\* to be loosely laid on top of the downlight without the need for additional accessories.



\* Ansell Lighting recommends good practise is adhered to by providing free air ventilation around the downlight



◀ Spring clip covers offer ceiling protection and comfort for the installer, whilst providing a tight and lasting positioning.

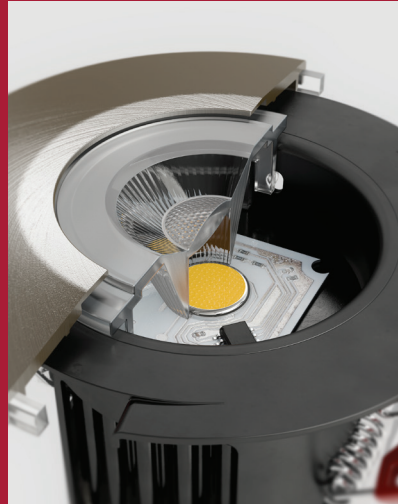

◀ Orbio360® achieves maximum efficiency through ground-breaking LED chip technology, delivering up to 550 lumens using just 7.6 watts. This coupled with a 60 degree beam angle provides a clear, precise and uniform light distribution with optimum glare reduction technology

▶ Unique quick release paddles allow easy access to socket terminations. Cables can be terminated directly into the socket with loop-in, loop-out cable connections.



▶ The distinctive heat sink design and cooling cylinders draw in the surrounding airflow from around the light source. The open steel cage design, together with our unique, patented intumescent disc, ensures that the area around the LED chip is temperature regulated.



# orbio360®

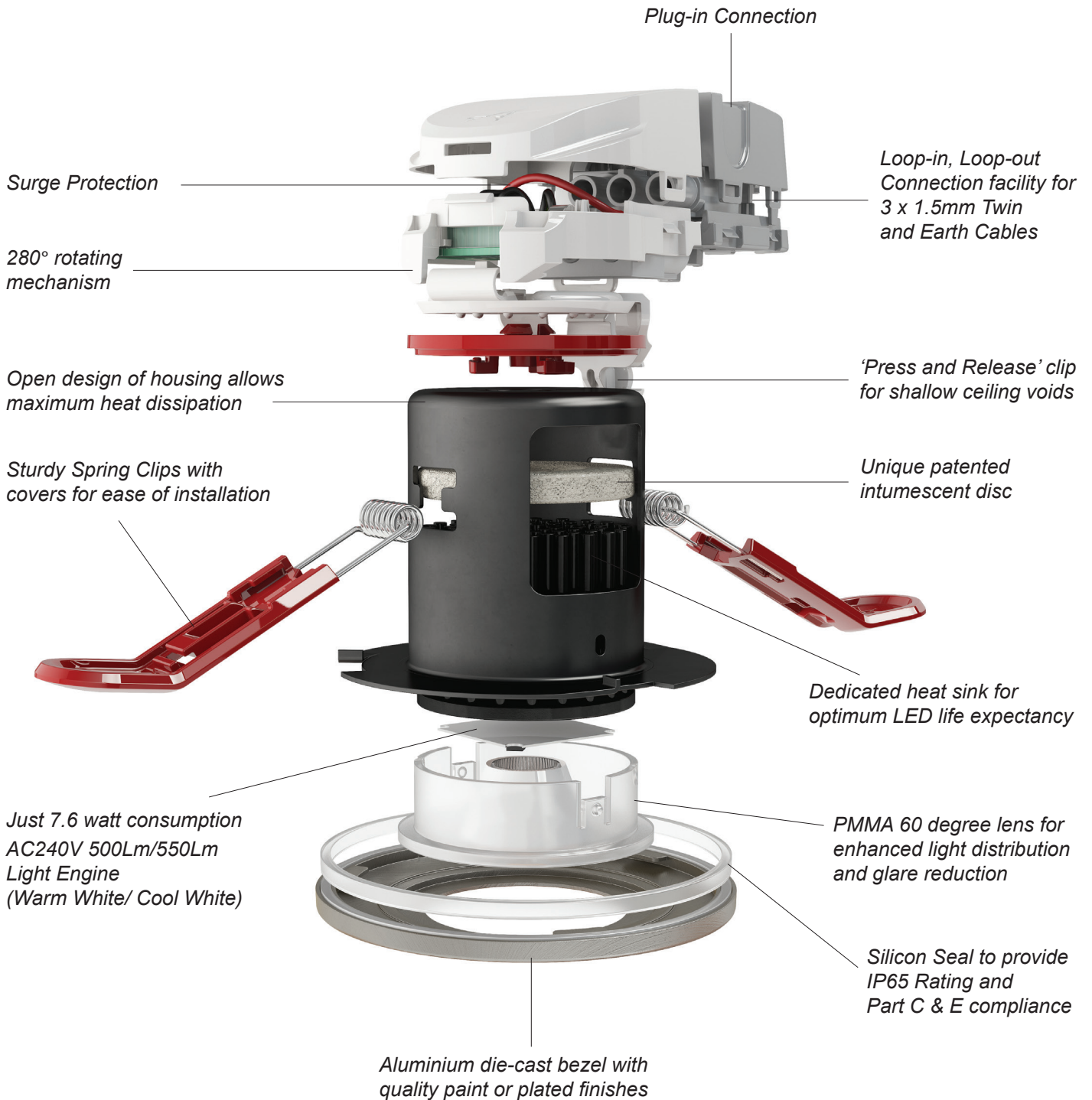

Orbio360® is fully adjustable for rotation and positioning next to those awkward joist locations often inaccessible for all other downlights. ▶

Orbio360's unique 'press, release and flip' feature - which allows the product to be installed in shallow ceiling voids of just 65mm - means that most height limitations can be overcome. ▼

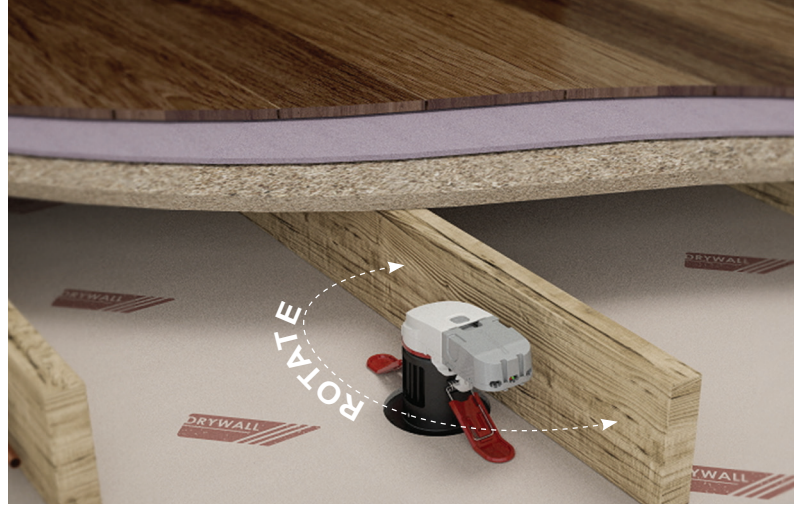

## REDUCED HEIGHT

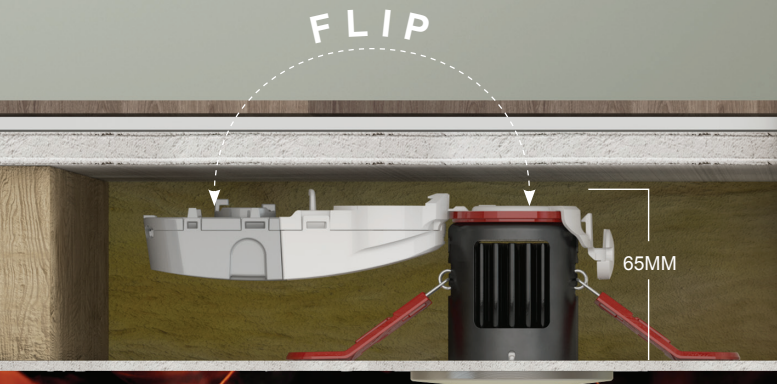

## FULL HEIGHT

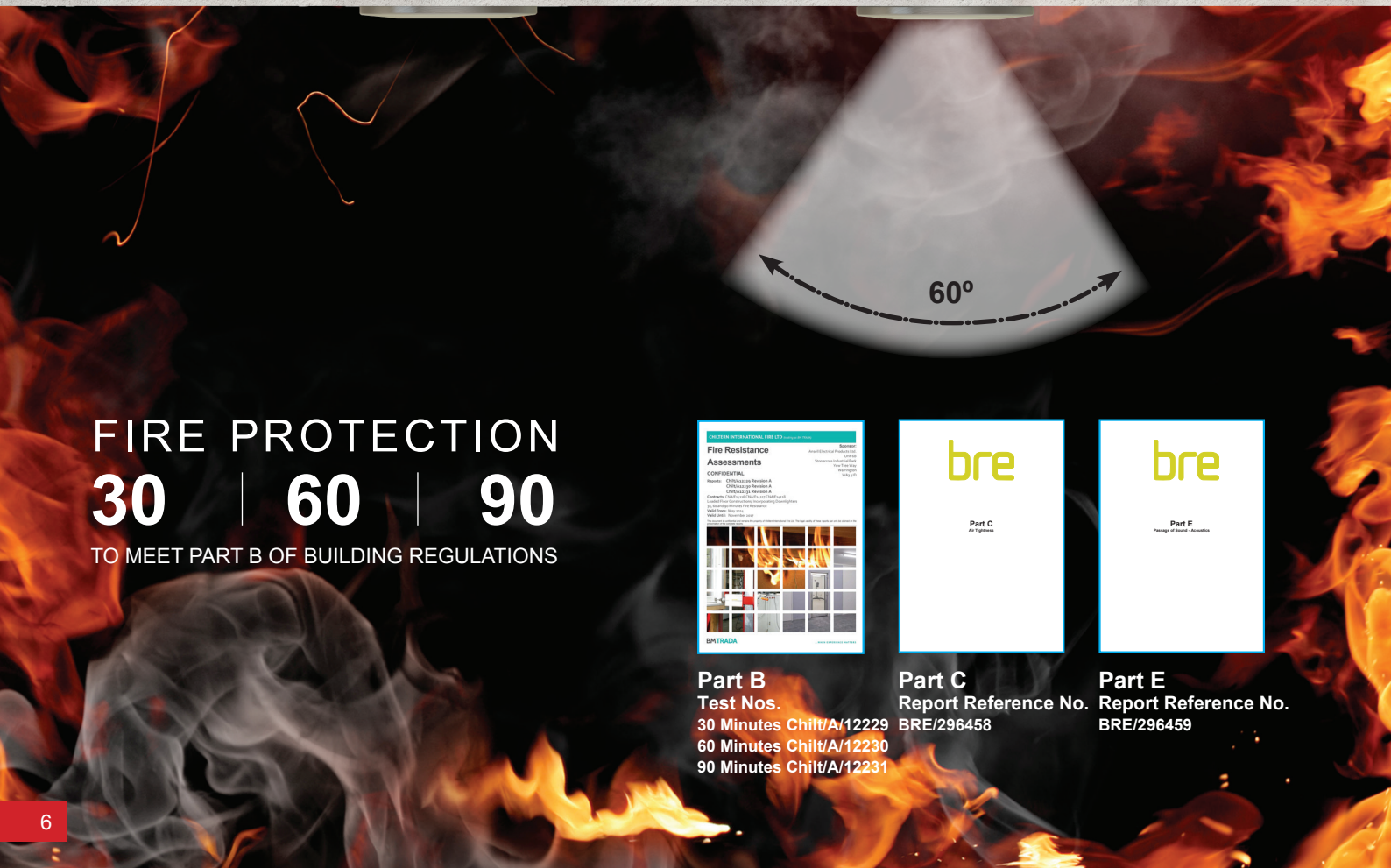
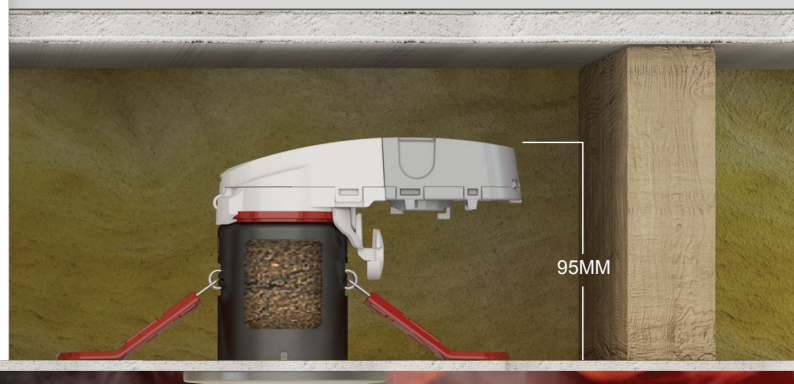

## FIRE PROTECTION

**30** | **60** | **90**

TO MEET PART B OF BUILDING REGULATIONS

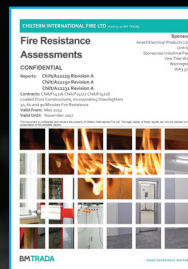

**Part B**  
Test Nos.  
30 Minutes Chilt/A/12229  
60 Minutes Chilt/A/12230  
90 Minutes Chilt/A/12231



**Part C**  
Report Reference No.  
BRE/296458



**Part E**  
Report Reference No.  
BRE/296459

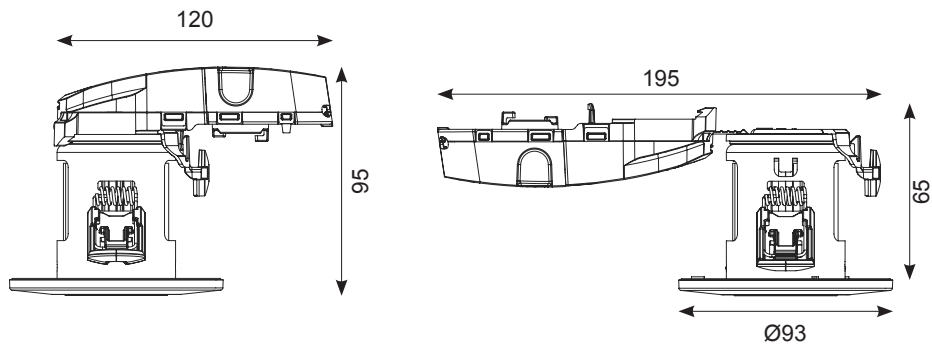

## Orbio360® Technical Information

<b>Output</b>	Fixed Output / Non Dimmable
<b>LED Colour Temperature (CCT)</b>	3000K / 4000K
<b>Component Materials</b>	Aluminium / Steel / Polycarbonate / Silicon / Carbon Spring Steel
<b>Bezel Supplied</b>	Matt White
<b>Bezel Accessories</b>	Brass / Chrome Gloss / Satin Chrome / Antique Brass / Black Chrome
<b>Ceiling Thickness</b>	5mm - 40mm
<b>Ceiling Cut Out</b>	76mm Diameter
<b>Ceiling Void (Minimum)</b>	65mm
<b>Dimensions</b>	(See line drawings above)
<b>Weight</b>	0.29kg
<b>Warranty</b>	5 Years Unregistered / 7 Years Registered
<b>Connections</b>	Plug and Play (accepts 3 x 1.5m Twin and Earth Cables)
<b>Beam Angle</b>	60°
<b>CRI</b>	Ra 80
<b>Input</b>	240V
<b>Luminous Flux</b>	550 Lumen Cool White / 500 Lumen Warm White
<b>Wattage</b>	7.6W
<b>Power Factor</b>	>0.9
<b>Luminous Efficiency</b>	72Lm/W Cool White / 67Lm/W Warm White
<b>Electrical Protection</b>	In-Built Surge Protection
<b>Part L1 Compliant</b>	YES
<b>Part L2 Compliant</b>	YES
<b>Fire Rating</b>	YES - 30 (Chilt/A/12229) / 60 (Chilt/A/12230) / 90 minutes (Chilt/A/12231)
<b>Acoustic Rating Part E</b>	YES - BRE/296439
<b>Air Tightness Part C</b>	YES - BRE/296438
<b>Ingress Protection</b>	IP65
<b>LED Average Lifetime</b>	50,000 Hours

CODE	DESCRIPTION
AORBLED/CW	7.6W Cool White
AORBLED/WW	7.6W Warm White

#### ACCESSORIES

CODE	DESCRIPTION
AORBLEDDBZ/BR	Brass Trim Bezel
AORBLEDDBZ/CH	Chrome Gloss Trim Bezel
AORBLEDDBZ/SC	Satin Chrome Trim Bezel
AORBLEDDBZ/AB	Antique Brass Trim Bezel
AORBLEDDBZ/BLC	Black Chrome Trim Bezel
ACFLP/3	Maintained/Non-Maintained Remote Emergency
ALEDCP/MW	Matt White Converter kit
ALEDCP/CH	Chrome Converter Kit
ALEDCP/SC	Satin Chrome Converter Kit



#### WARRANTY

5 year unregistered 7 year registered.  
Please see details on exclusion to warranty  
on installation instructions or online at

[www.anselluk.com](http://www.anselluk.com)

#### **Ansell Electrical Products Limited**

Unit 6B Stonecross Ind. Park  
Yew Tree Way  
Warrington  
Cheshire  
WA3 3JD

Phone: +44 (0)1942 433 333

Fax: +44 (0)1942 433 433

Email: [saleswarrington@anselluk.com](mailto:saleswarrington@anselluk.com)

#### **Ansell Sales and Distribution Limited**

Unit 2, M2 Business Park  
Duncrue Street  
Belfast  
BT3 9AQ

Phone: +44 (0)2890 773 750

Fax: +44 (0)2890 773 783

Email: [sales@anselluk.com](mailto:sales@anselluk.com)

**orbio360**

**IP65 AC 240V LED Fire Rated Downlight**